



República Federativa do Brasil  
Ministério da Economia  
Instituto Nacional da Propriedade Industrial

(11) **BR 302021005021-8**

(22) **Data do Depósito:** 11/10/2021

(45) **Data da Publicação do Registro:**  
03/11/2021

**Decisão: Concessão do Registro**



(54) **Título:** CONFIGURAÇÃO APLICADA A/EM  
ESTRUTURA DE QUIOSQUE

(15) **Data da Concessão do Registro:**  
03/11/2021

(17) **Prazo de Validade:** 10(dez) anos contados  
a partir de 11/10/2021, mediante o recolhimento  
da taxa quinquenal de manutenção (Artigos 119  
e 120 da LPI) e observadas as demais  
condições legais.

(51) **Int. Cl.:** 25-03.

(73) **Titular(es):** JANIO SILVA DOS SANTOS.

(72) **Autor(es):** JANIO SILVA DOS SANTOS.

(74) **Procurador(es):** ANEL MARCAS E  
PATENTES LTDA

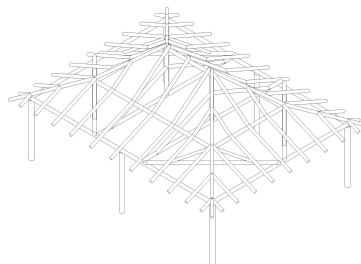

**RELATÓRIO DESCRITIVO**

**CONFIGURAÇÃO APLICADA EM ESTRUTURA DE QUIOSQUE**

O presente relatório descritivo faz referência aos desenhos anexos assim indicados:

Figura 1.1 – Perspectiva superior;

Figura 1.2 – Perspectiva inferior;

Figura 1.3 – Vista anterior;

Figura 1.4 – Vista posterior;

Figura 1.5 – Vista lateral direita;

Figura 1.6 – Vista lateral esquerda;

Figura 1.7 – Vista superior;

Figura 1.8 – Vista inferior;

Figura 2.1 – Perspectiva superior;

Figura 2.2 – Perspectiva inferior;

Figura 2.3 – Vista anterior;

Figura 2.4 – Vista posterior;

Figura 2.5 – Vista lateral direita;

Figura 2.6 – Vista lateral esquerda;

Figura 2.7 – Vista superior;

Figura 2.8 – Vista inferior;

Figura 3.1 – Perspectiva superior;

Figura 3.2 – Perspectiva inferior;

Figura 3.3 – Vista anterior;

Figura 3.4 – Vista posterior;

Figura 3.5 – Vista lateral direita;

Figura 3.6 – Vista lateral esquerda;

Figura 3.7 – Vista superior;

Figura 3.8 – Vista inferior;

Figura 4.1 – Perspectiva superior;

Figura 4.2 – Perspectiva inferior;

Figura 4.3 – Vista anterior;

Figura 4.4 – Vista posterior;

Figura 4.5 – Vista lateral direita;

Figura 4.6 – Vista lateral esquerda;

Figura 4.7 – Vista superior;

Figura 4.8 – Vista inferior.

**REIVINDICAÇÃO**  
**CONFIGURAÇÃO APLICADA EM ESTRUTURA DE**  
**QUIOSQUE**

Reivindica-se o registro do desenho industrial conforme representado no conjunto de figuras e apresentado no relatório descritivo, ambos em anexo.

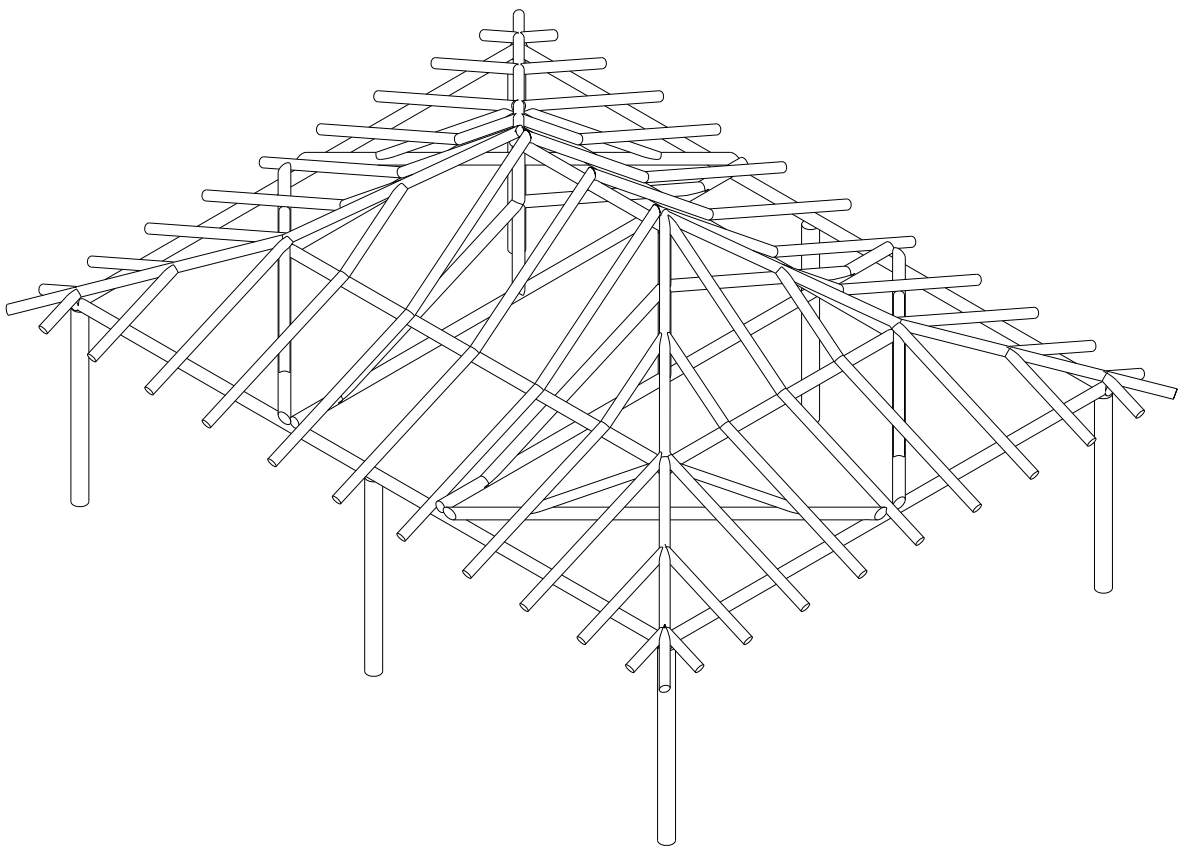

FIG 1.1

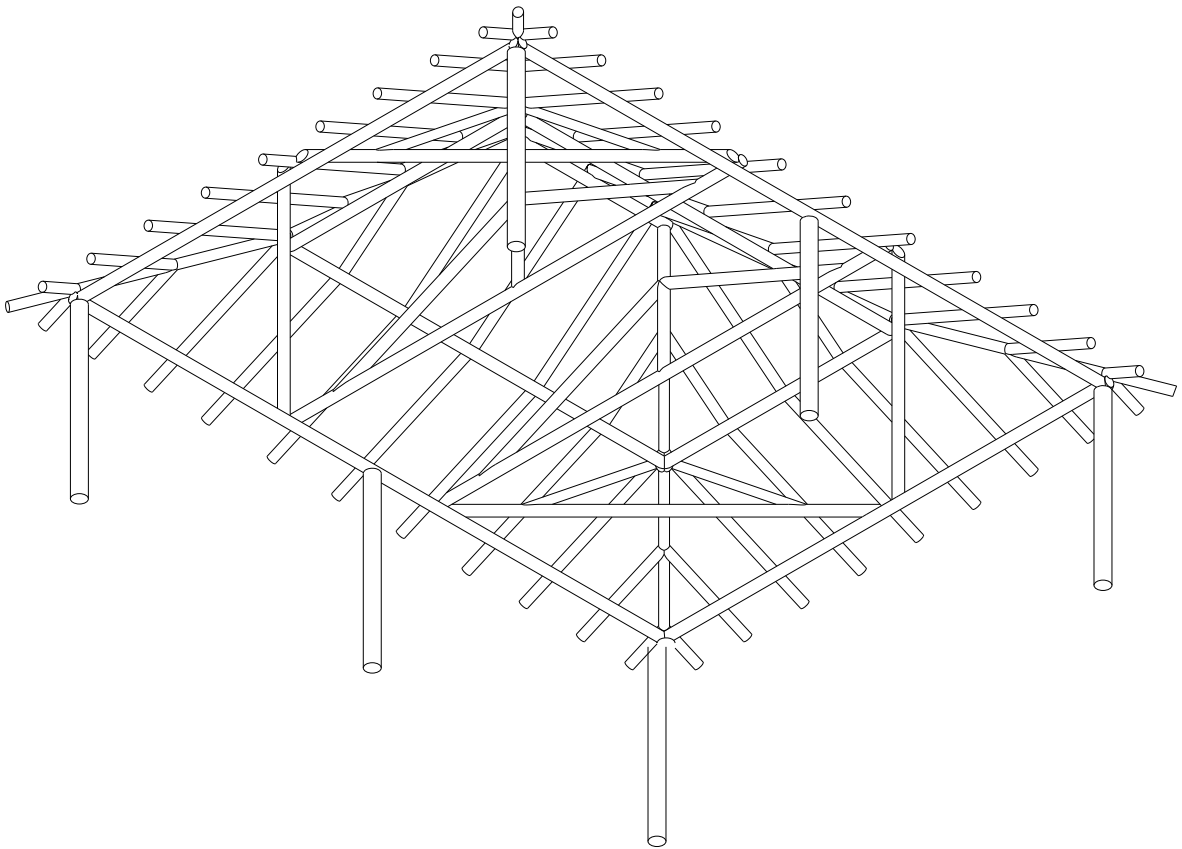

FIG 1.2

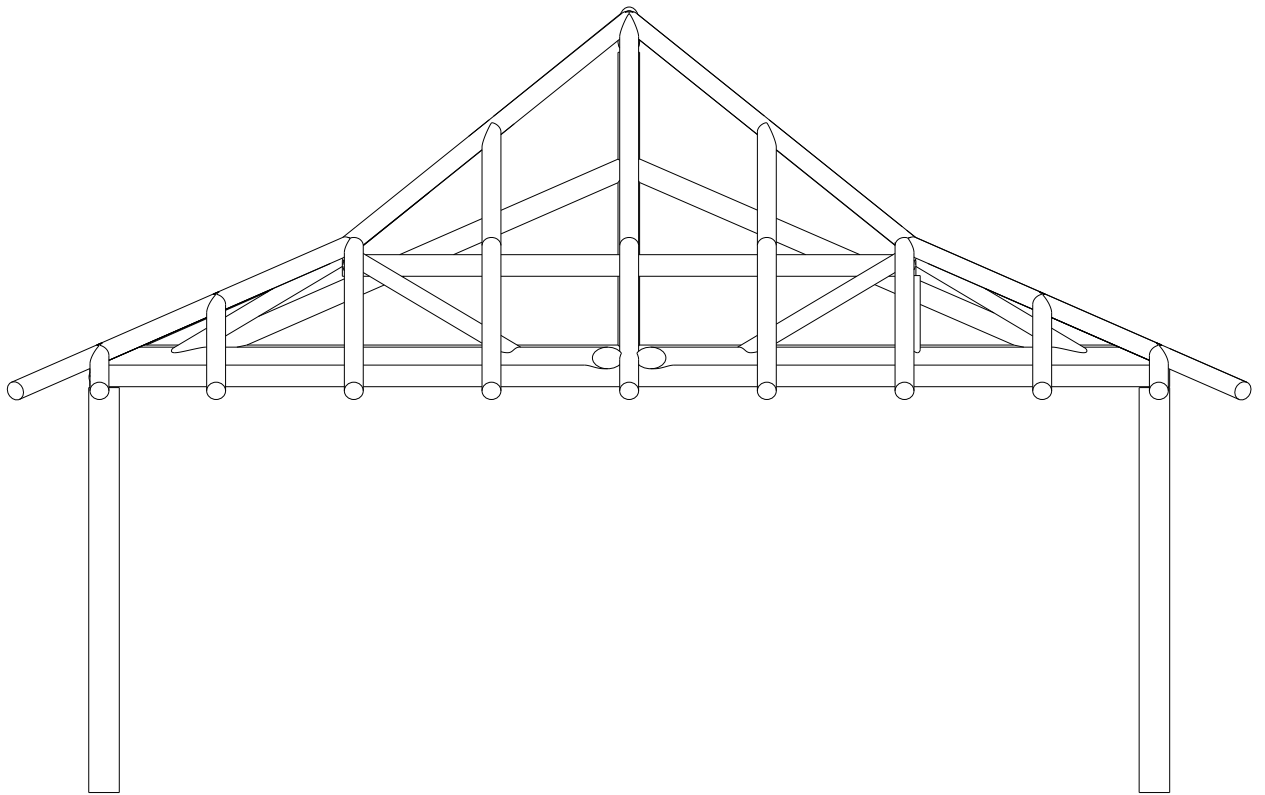

FIG 1.3

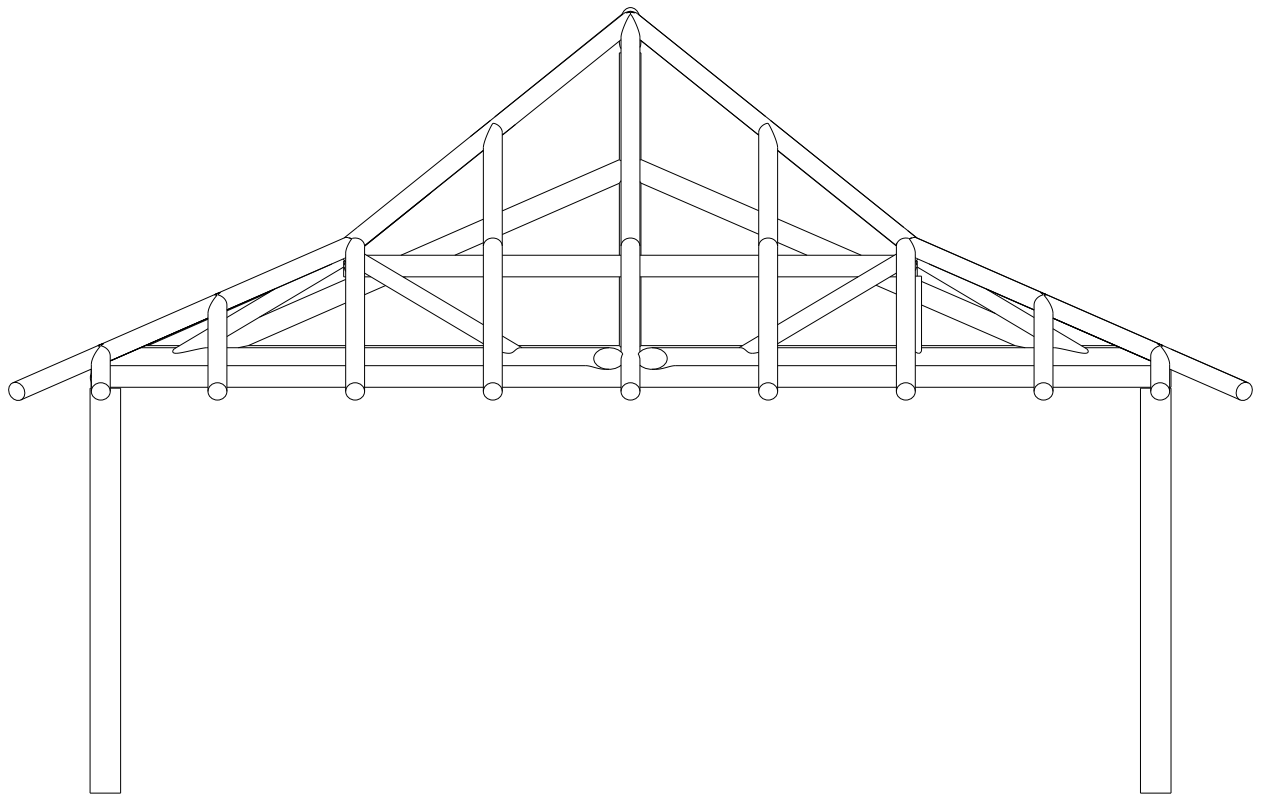

FIG 1.4



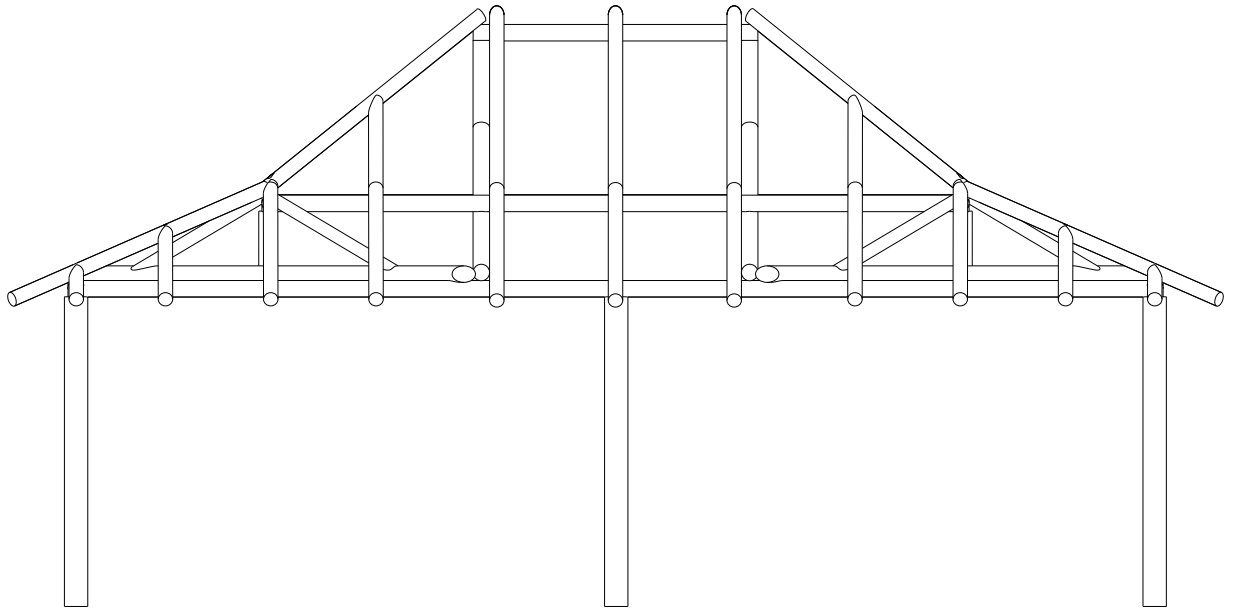

FIG 1.5

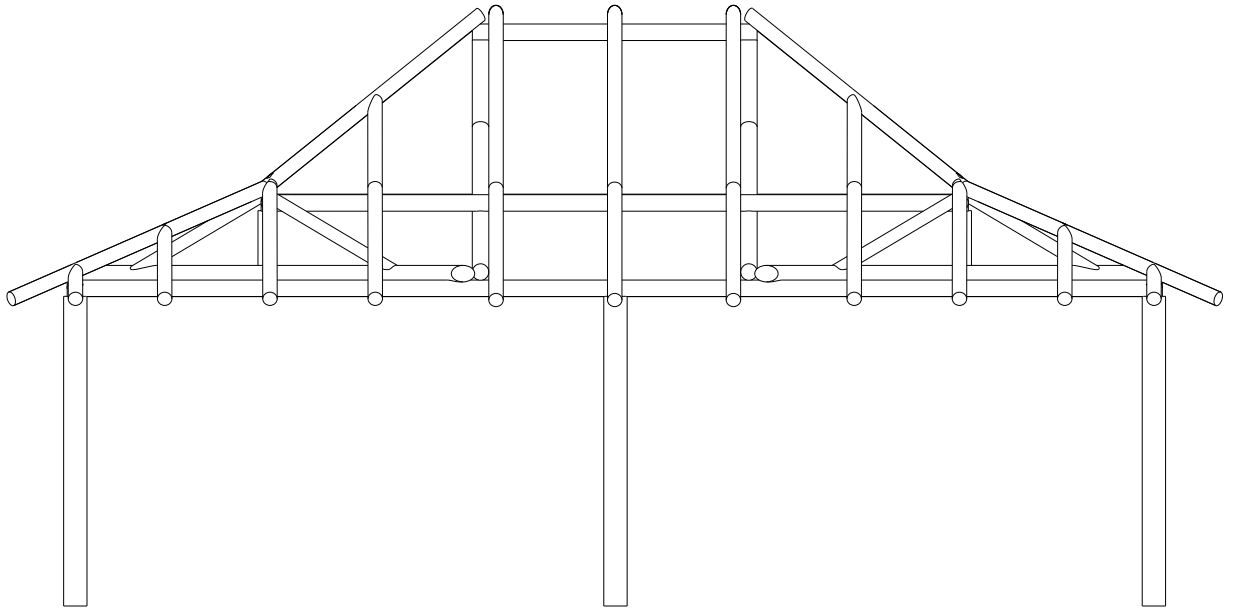

FIG 1.6

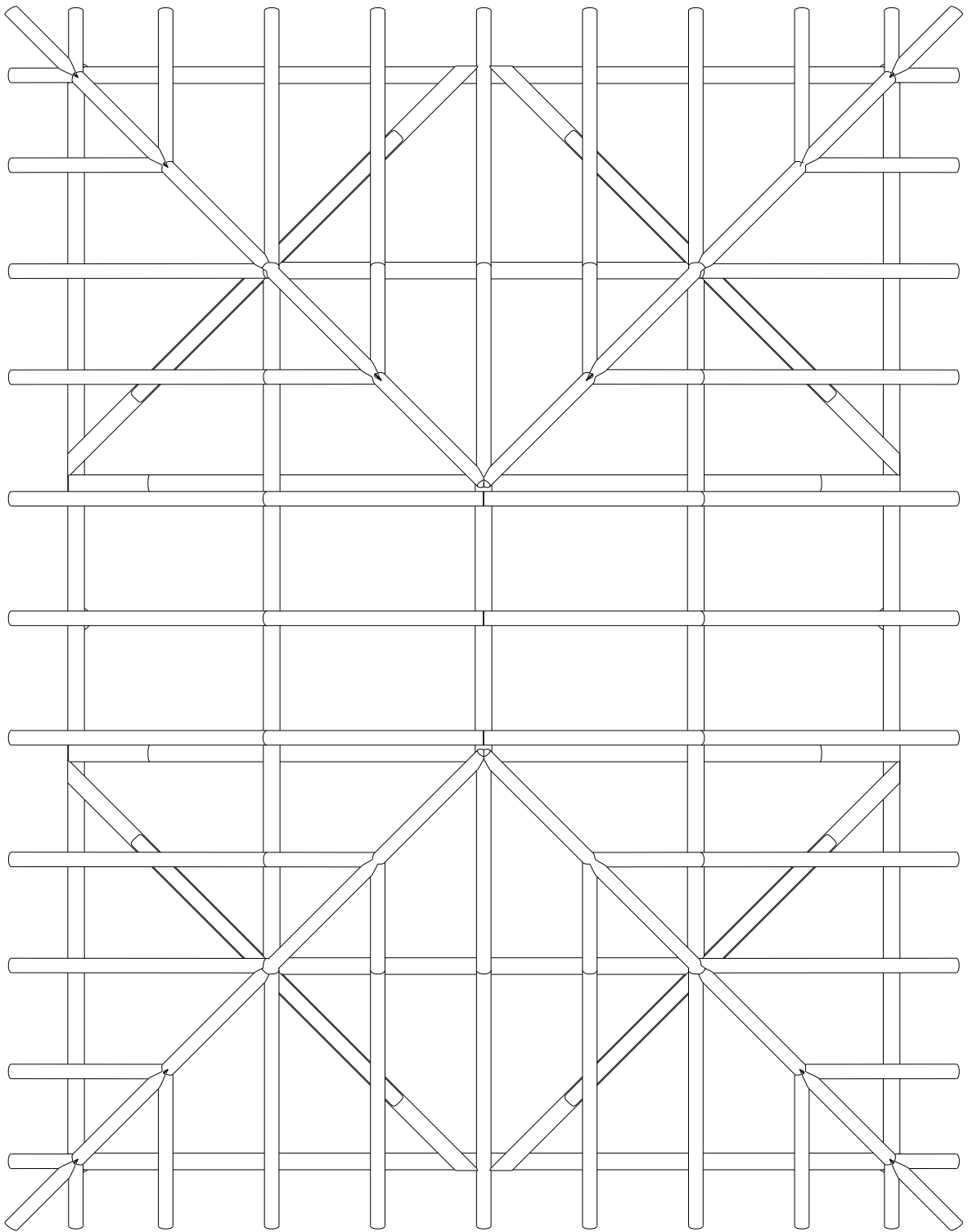

FIG 1.7

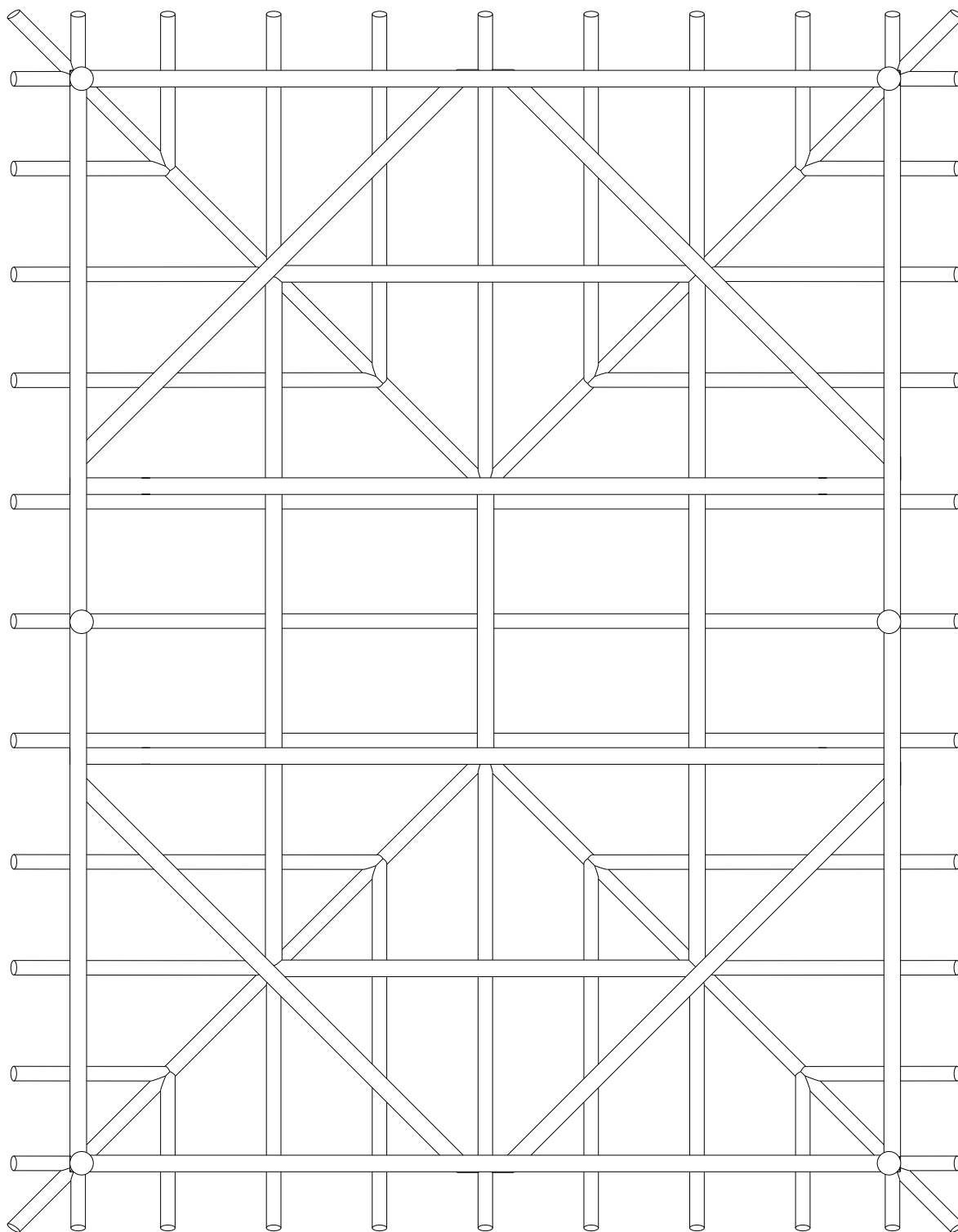

FIG 1.8

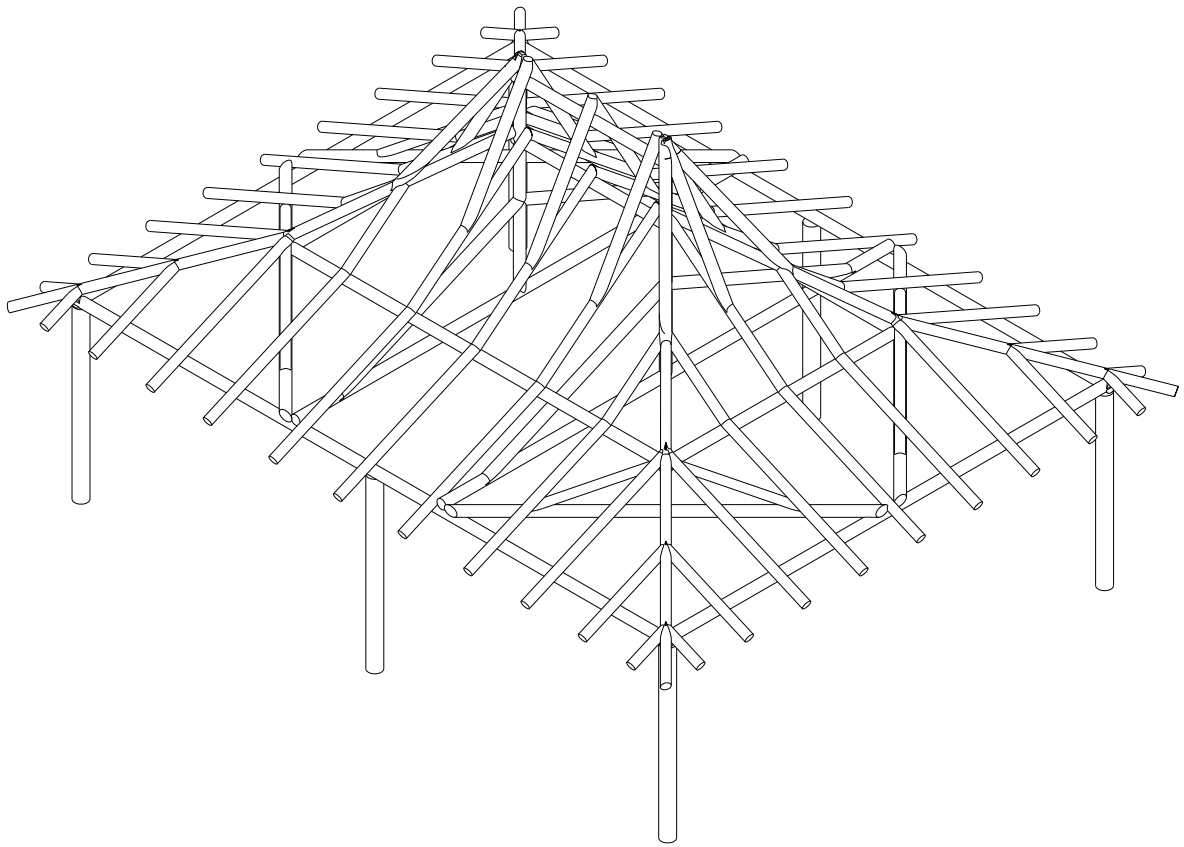

FIG 2.1

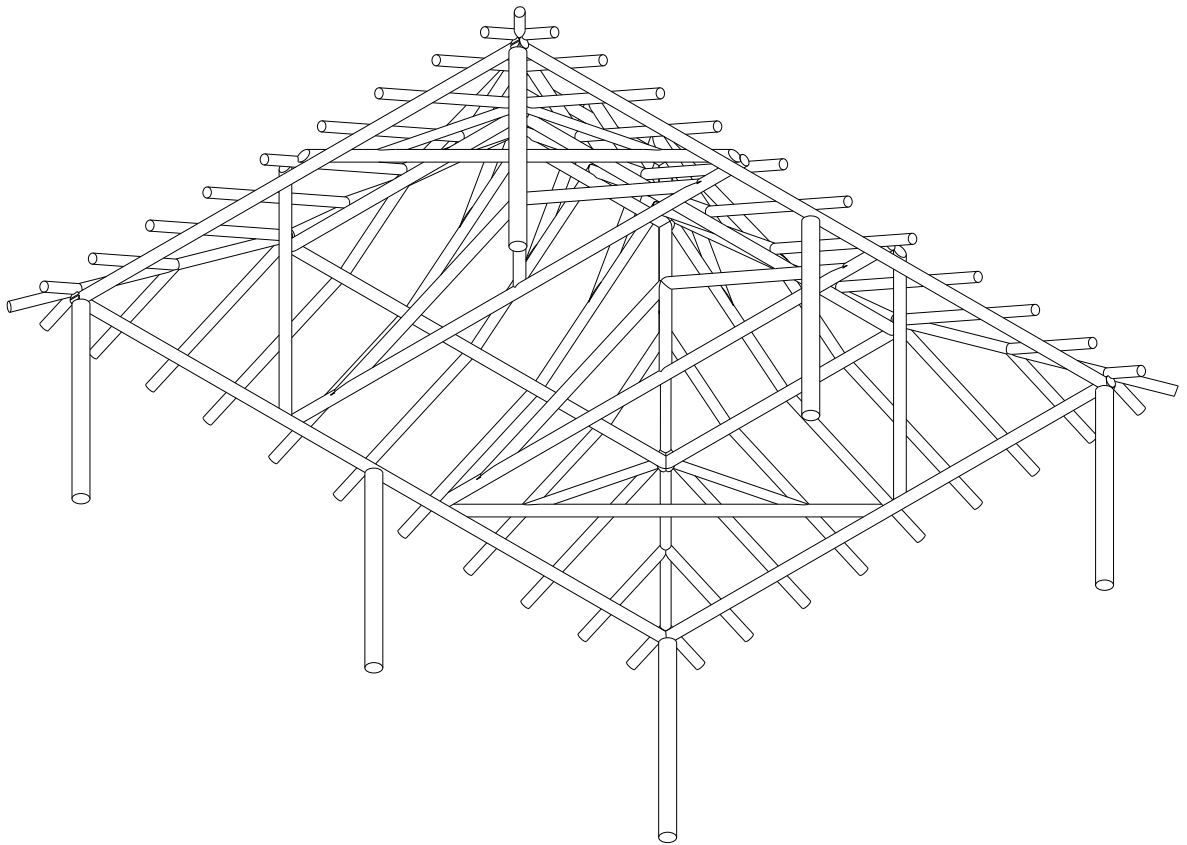

FIG 2.2

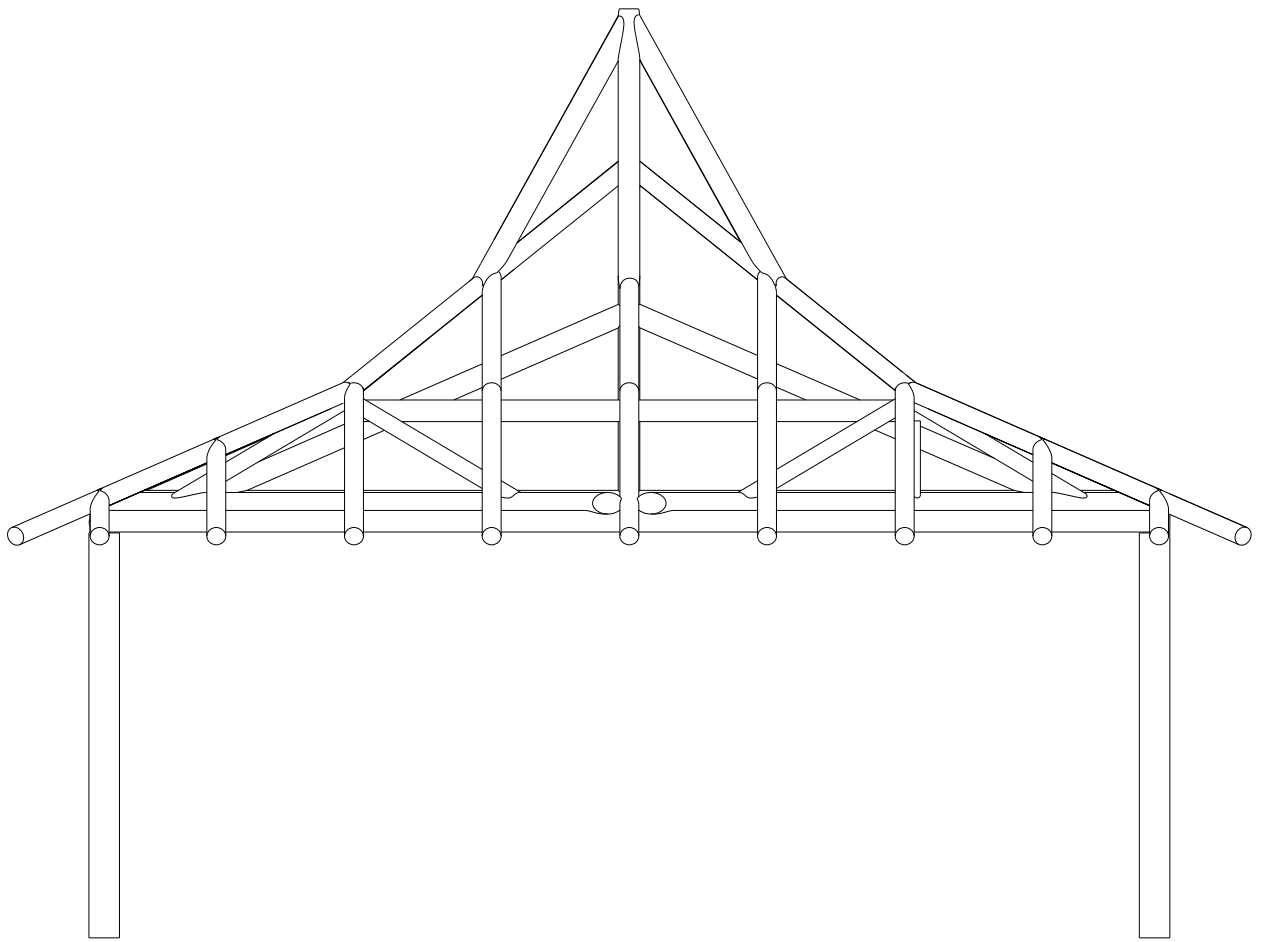

FIG 2.3

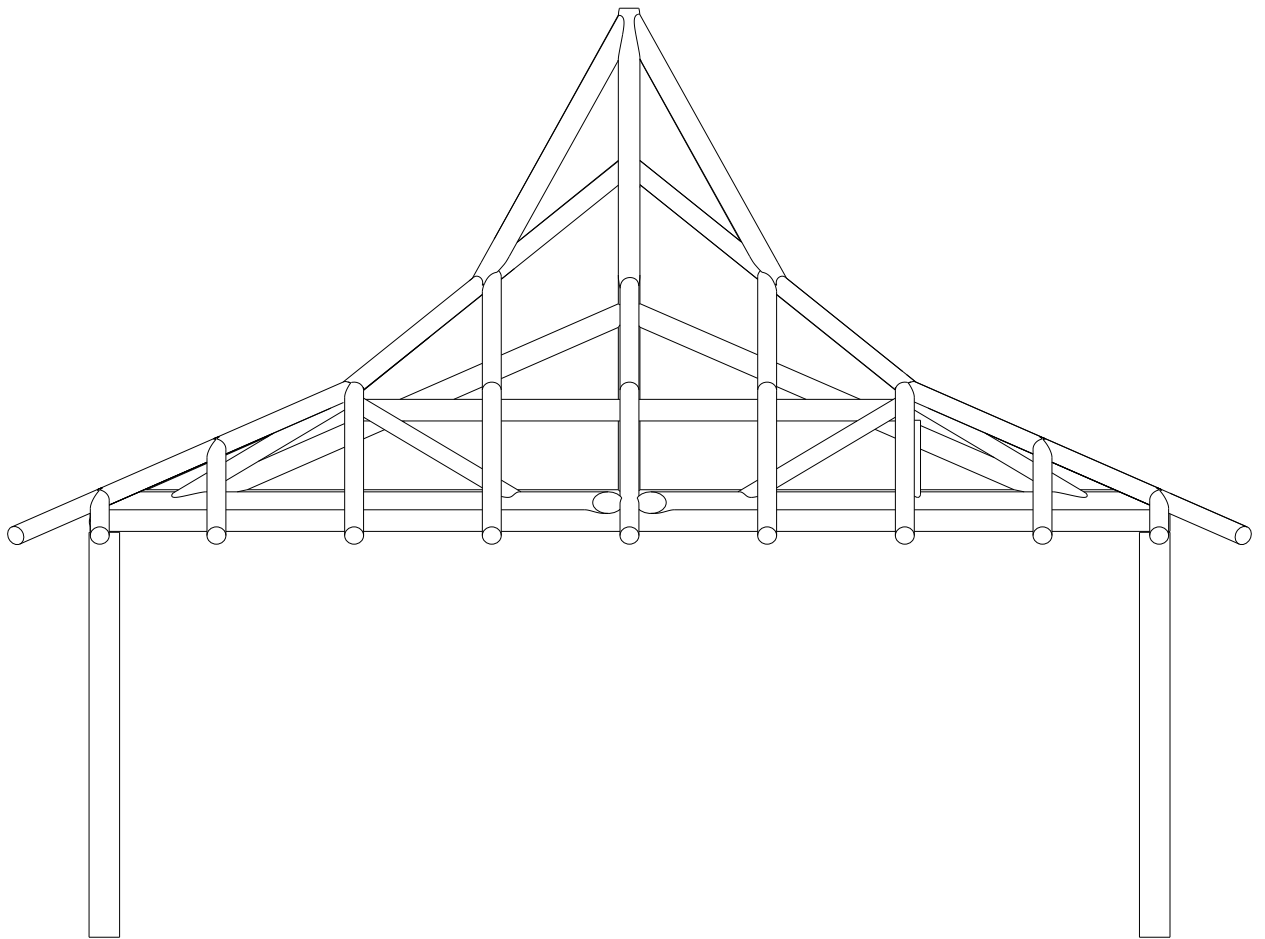

FIG 2.4



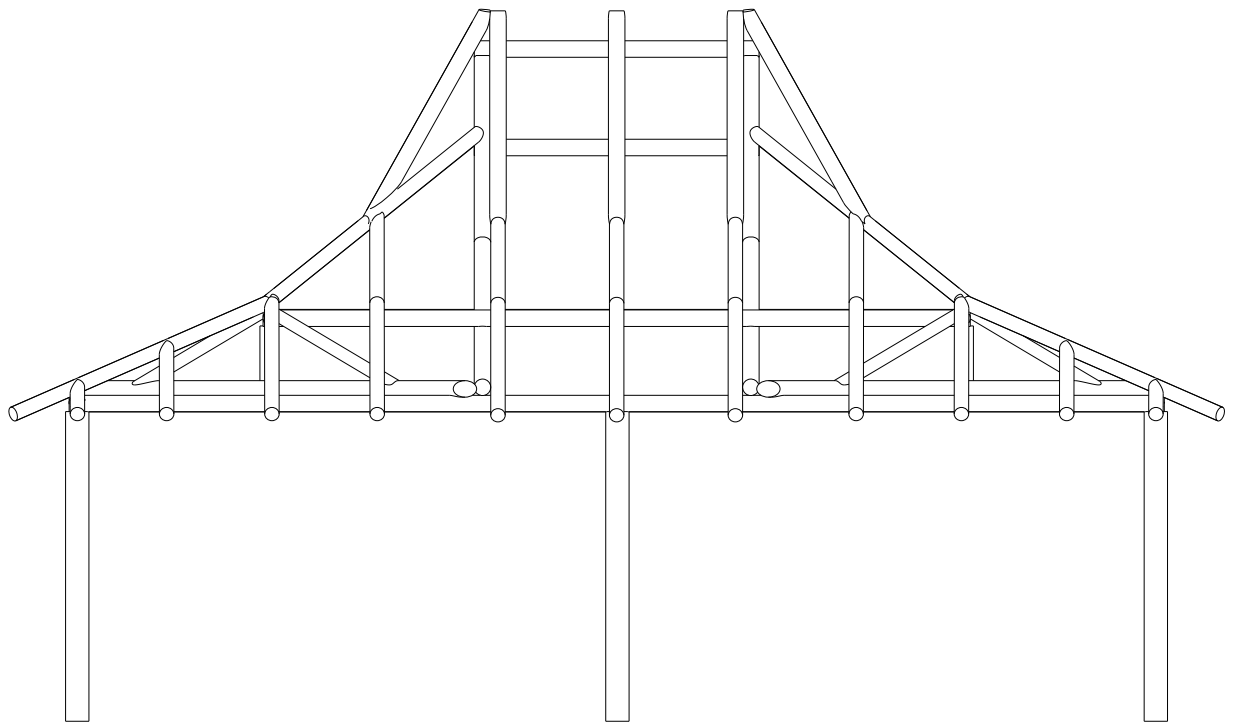

FIG 2.5

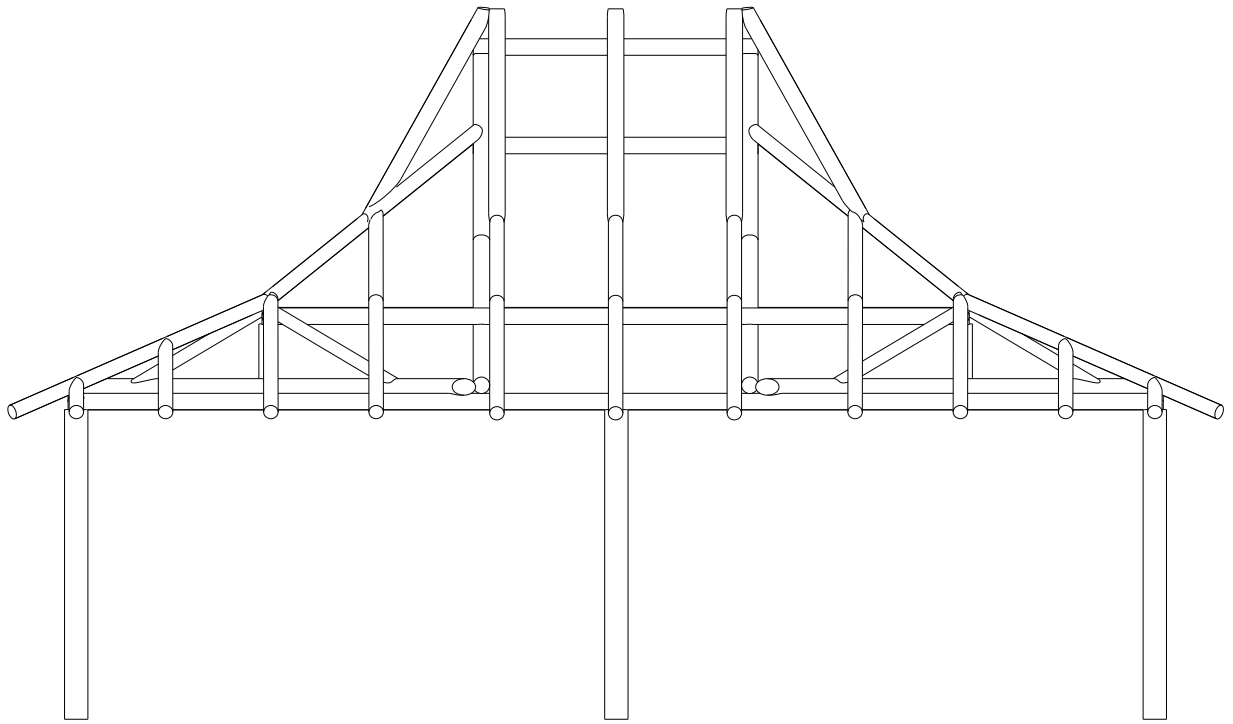

FIG 2.6

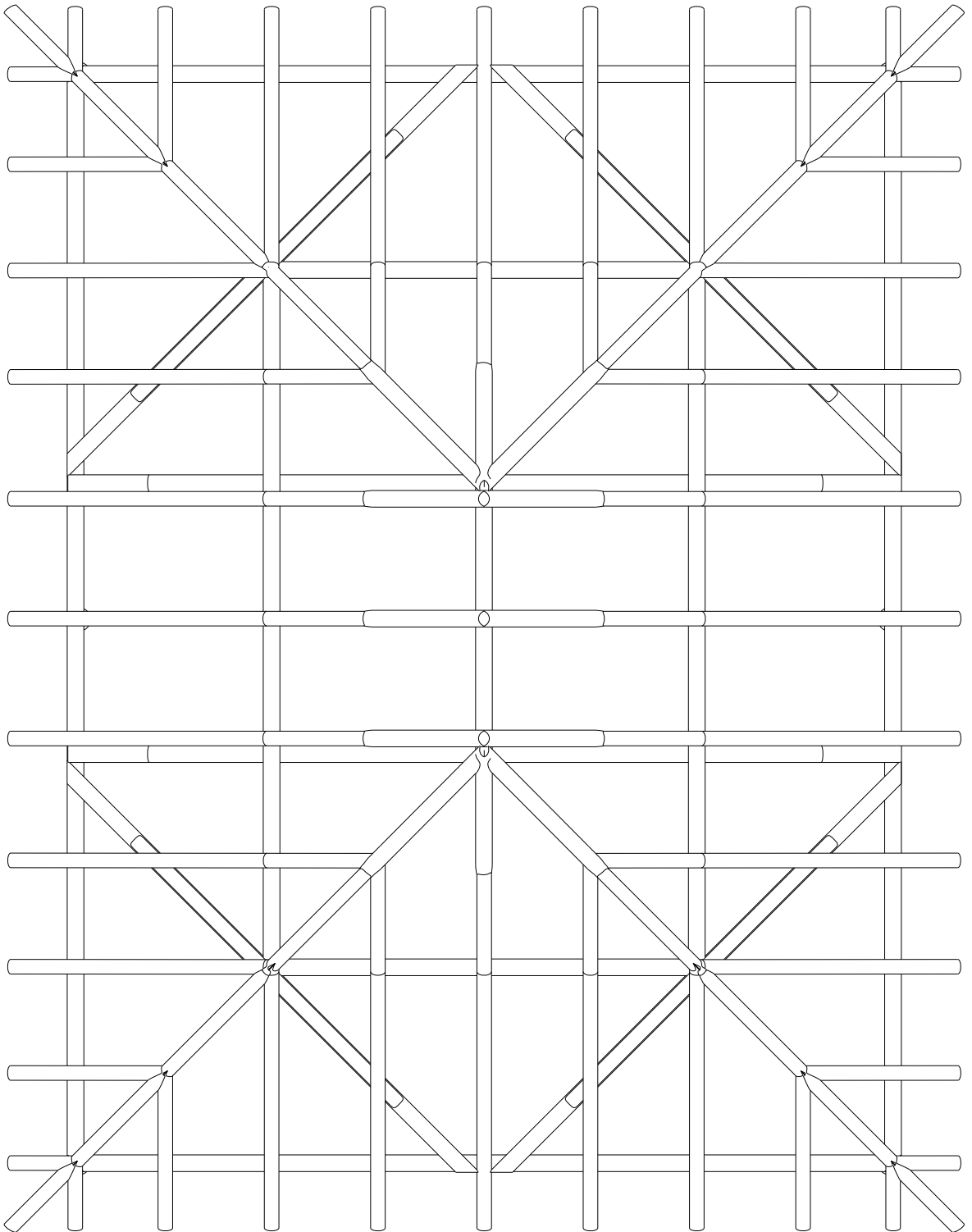

FIG 2.7

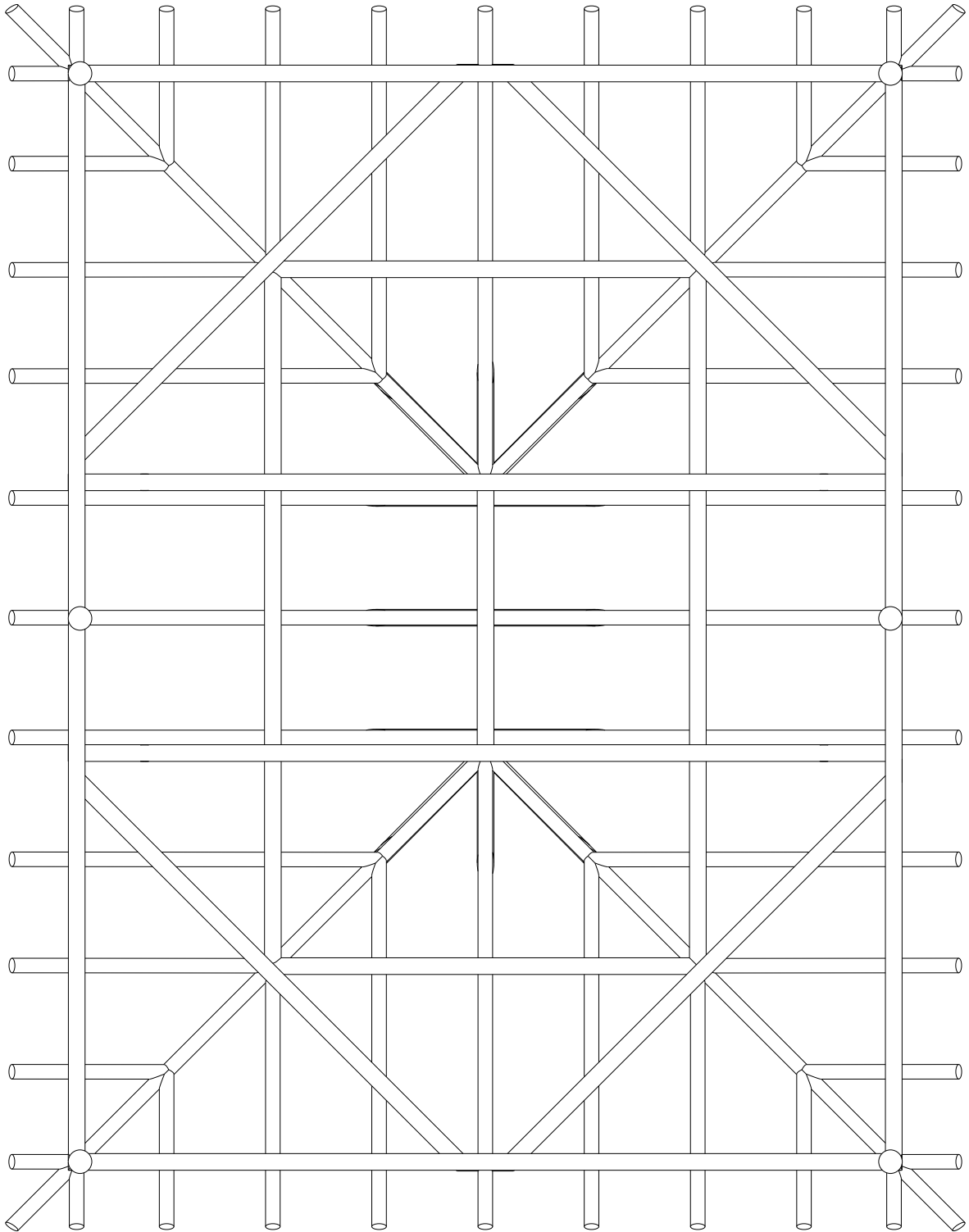

FIG 2.8

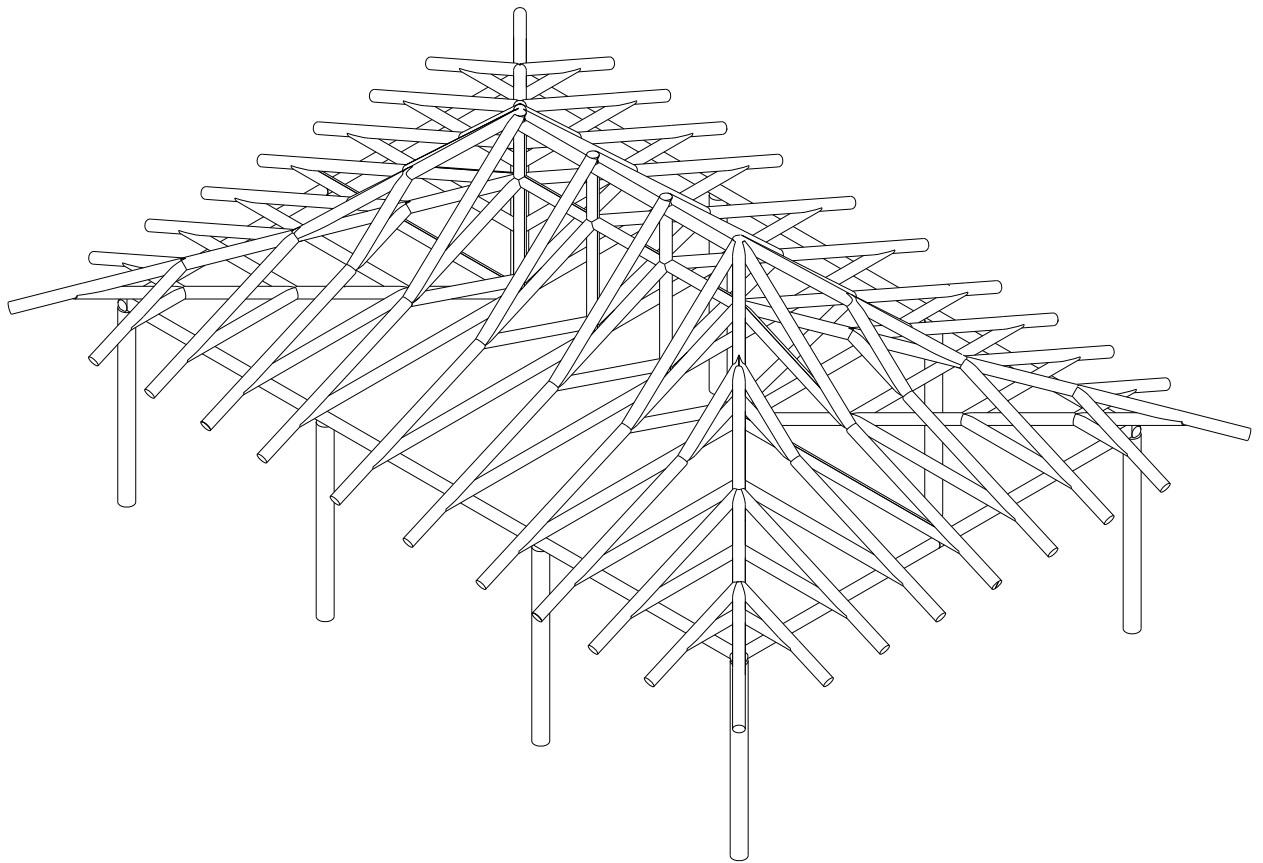

FIG 3.1

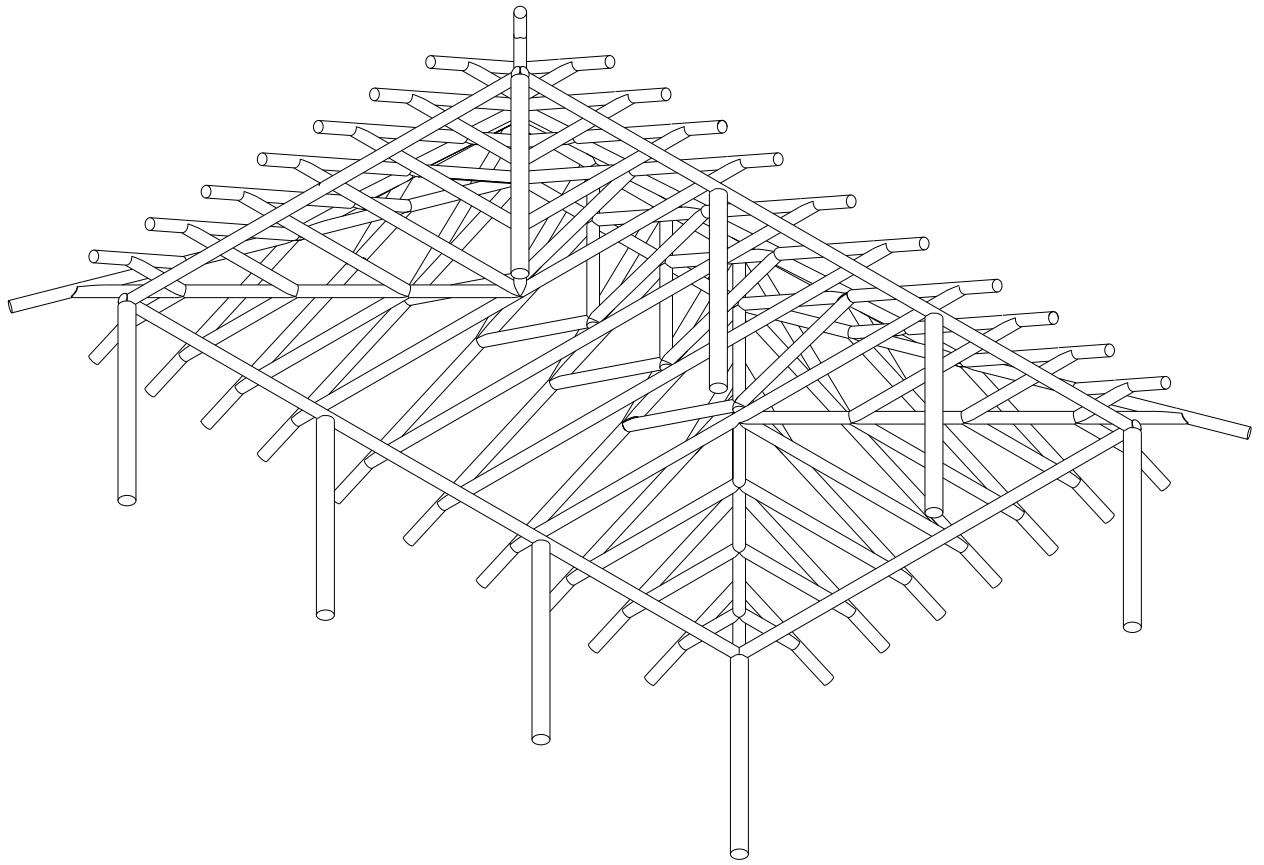

FIG 3.2



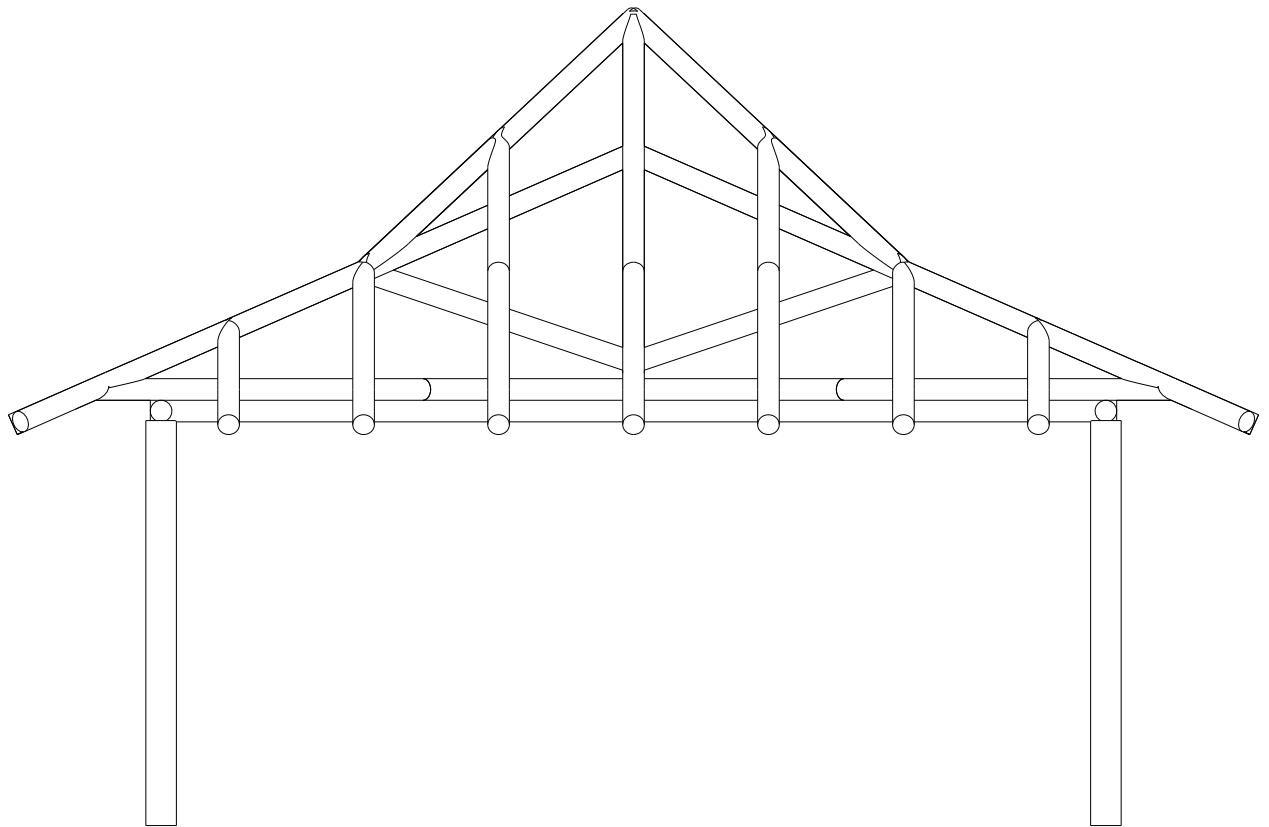

FIG 3.4



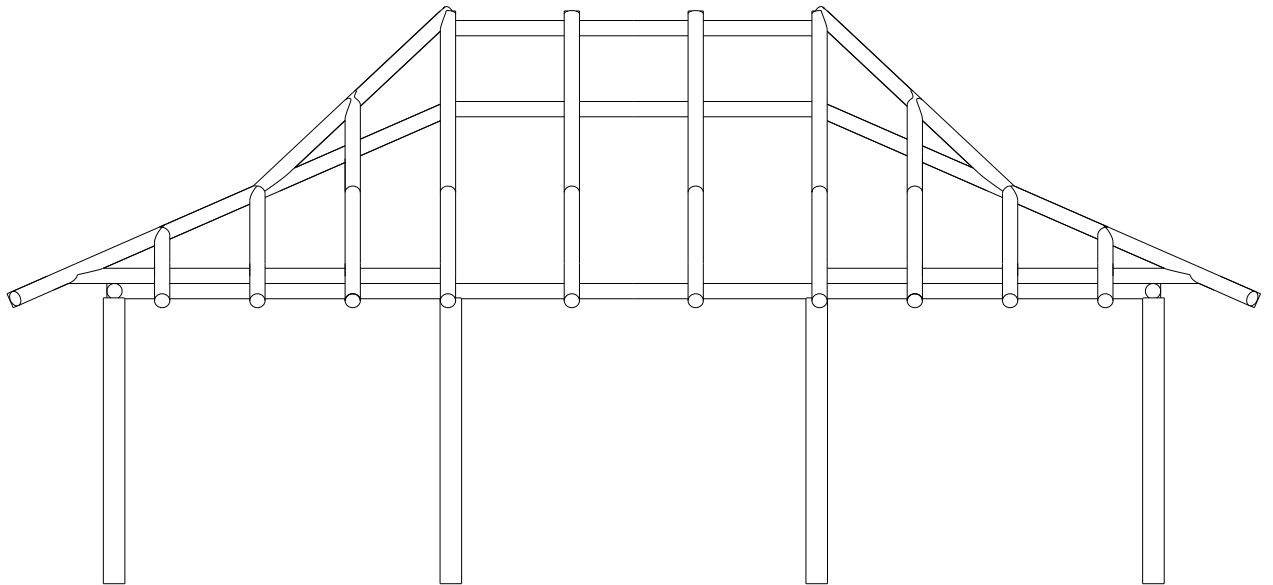

FIG 3.5

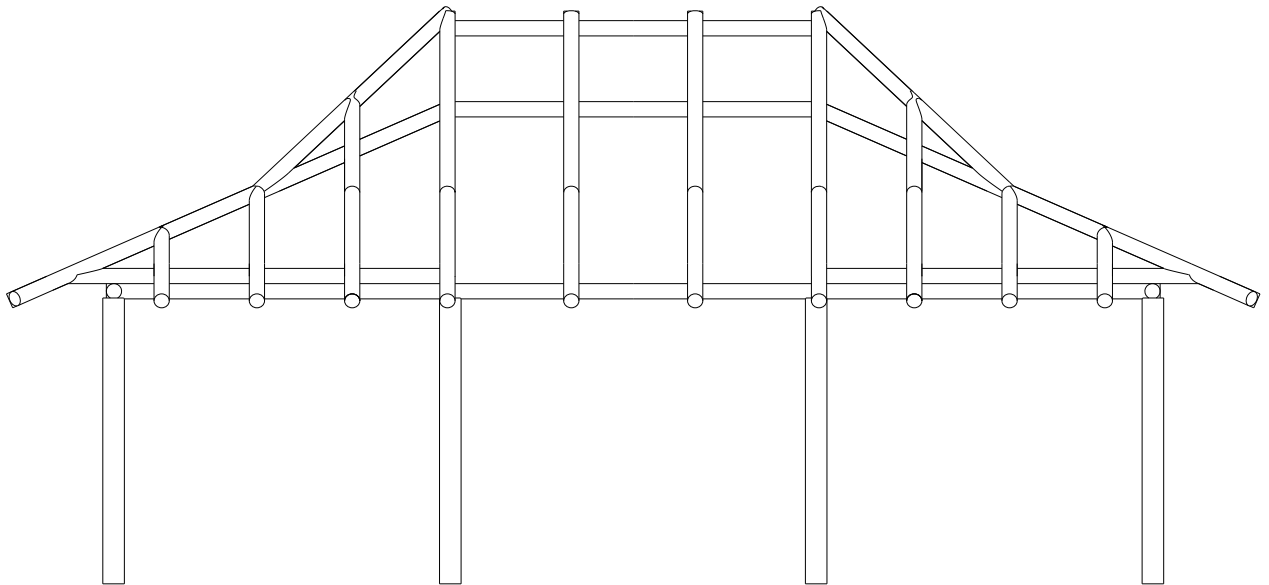

FIG 3.6

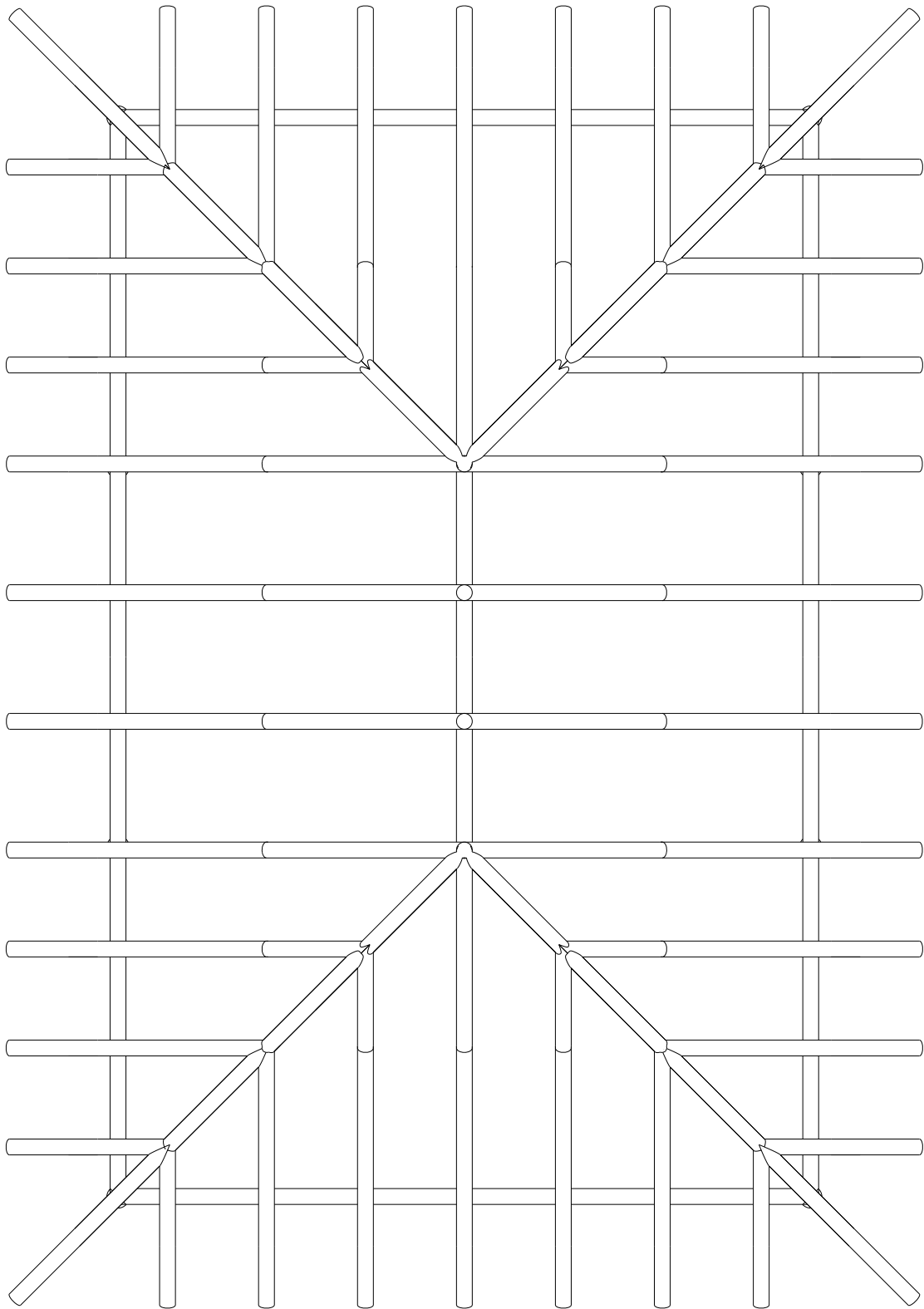

FIG 3.7



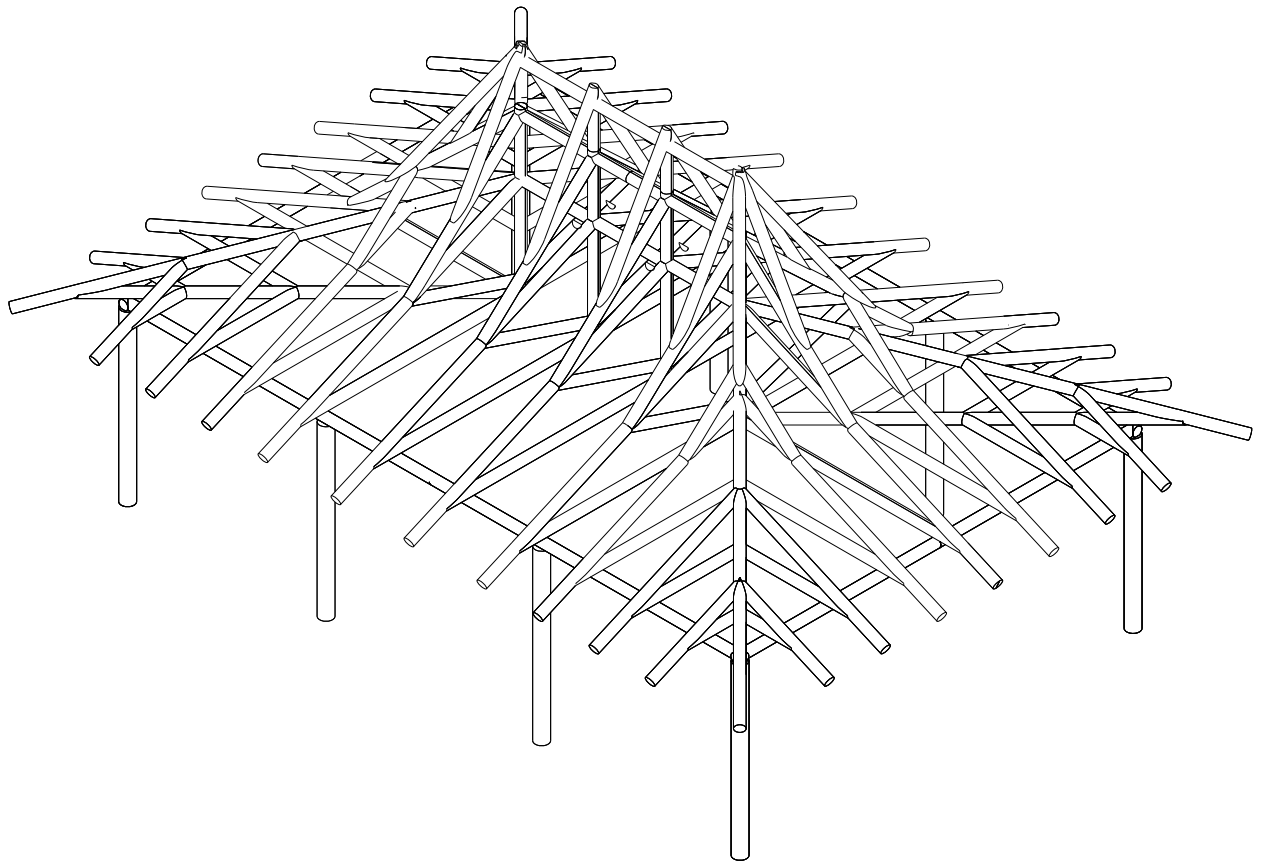

FIG 4.1

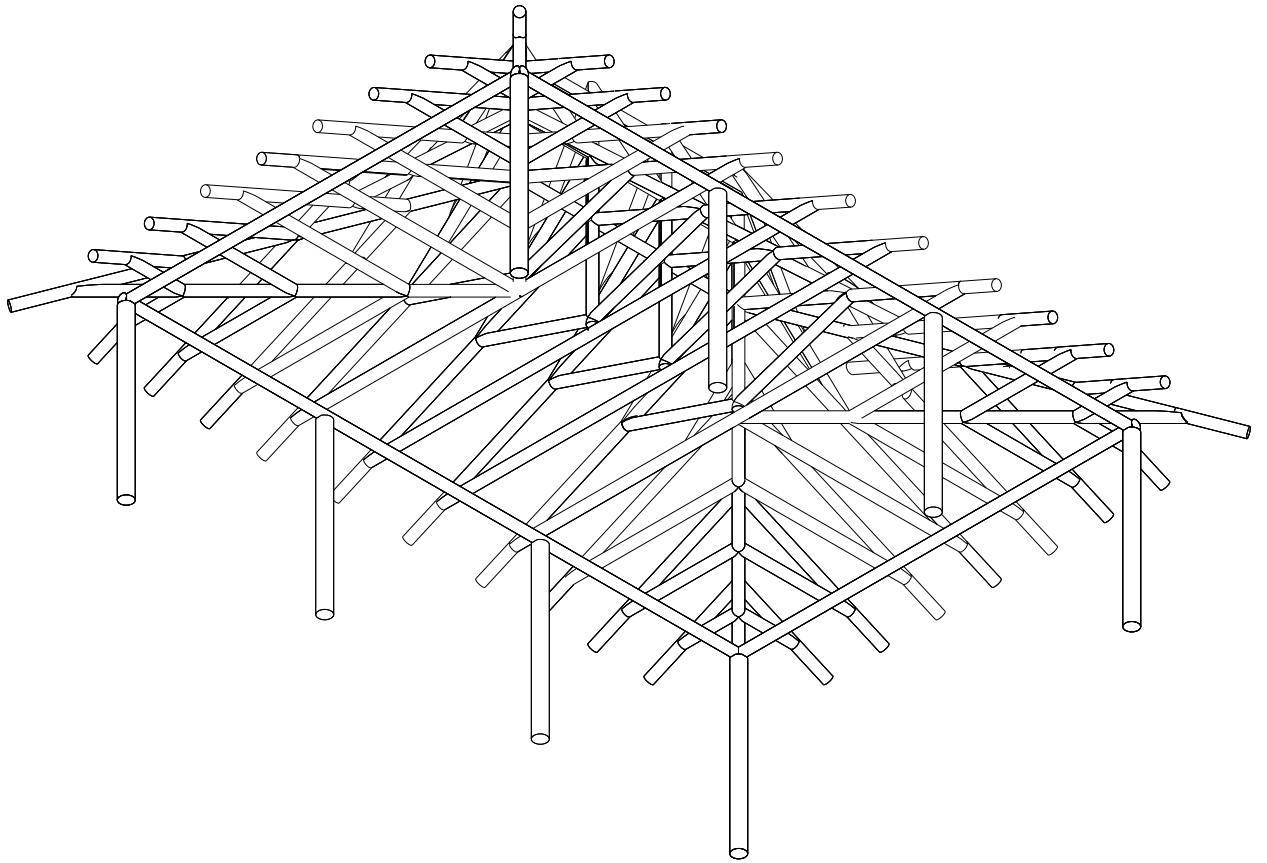

FIG 4.2

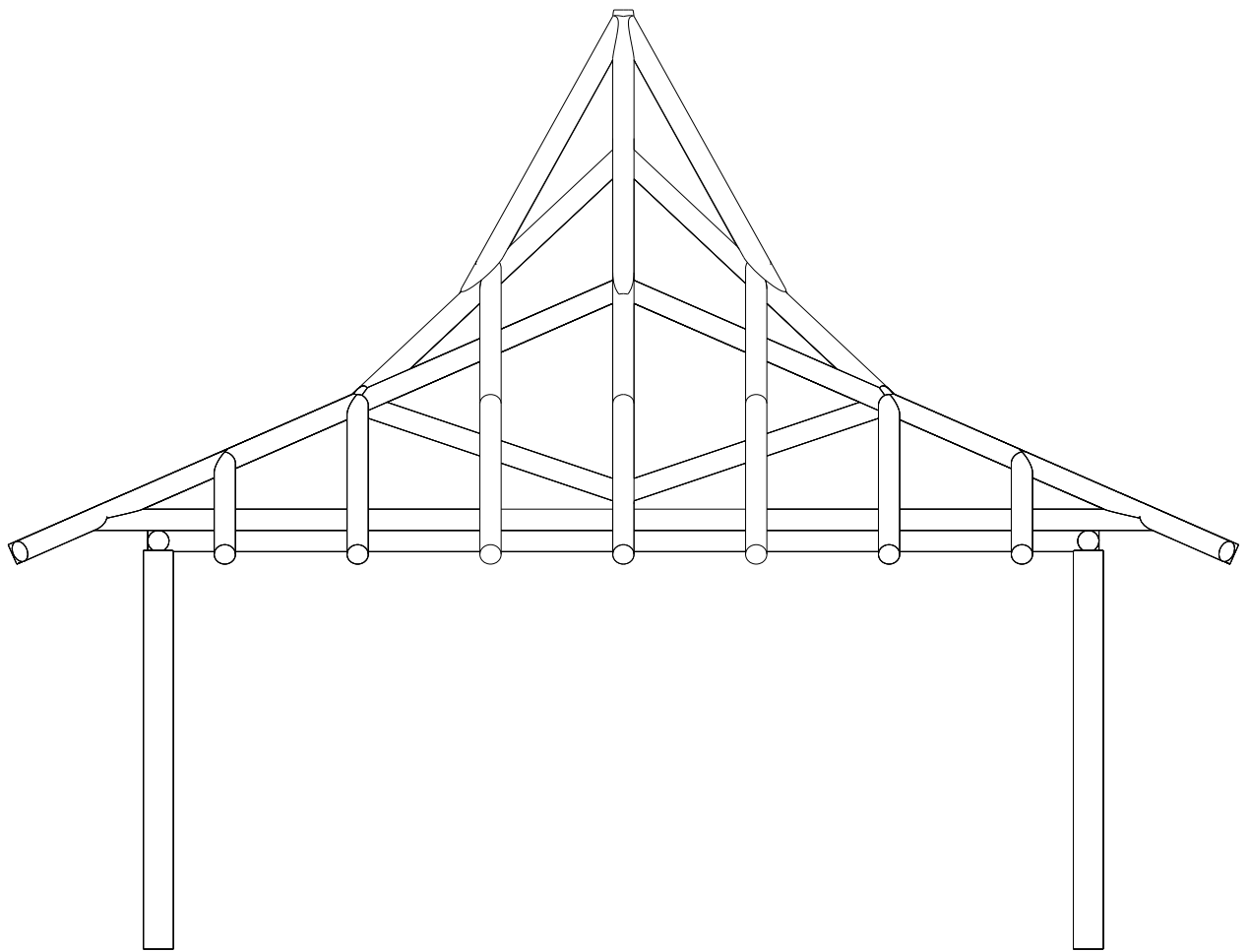

FIG 4.3

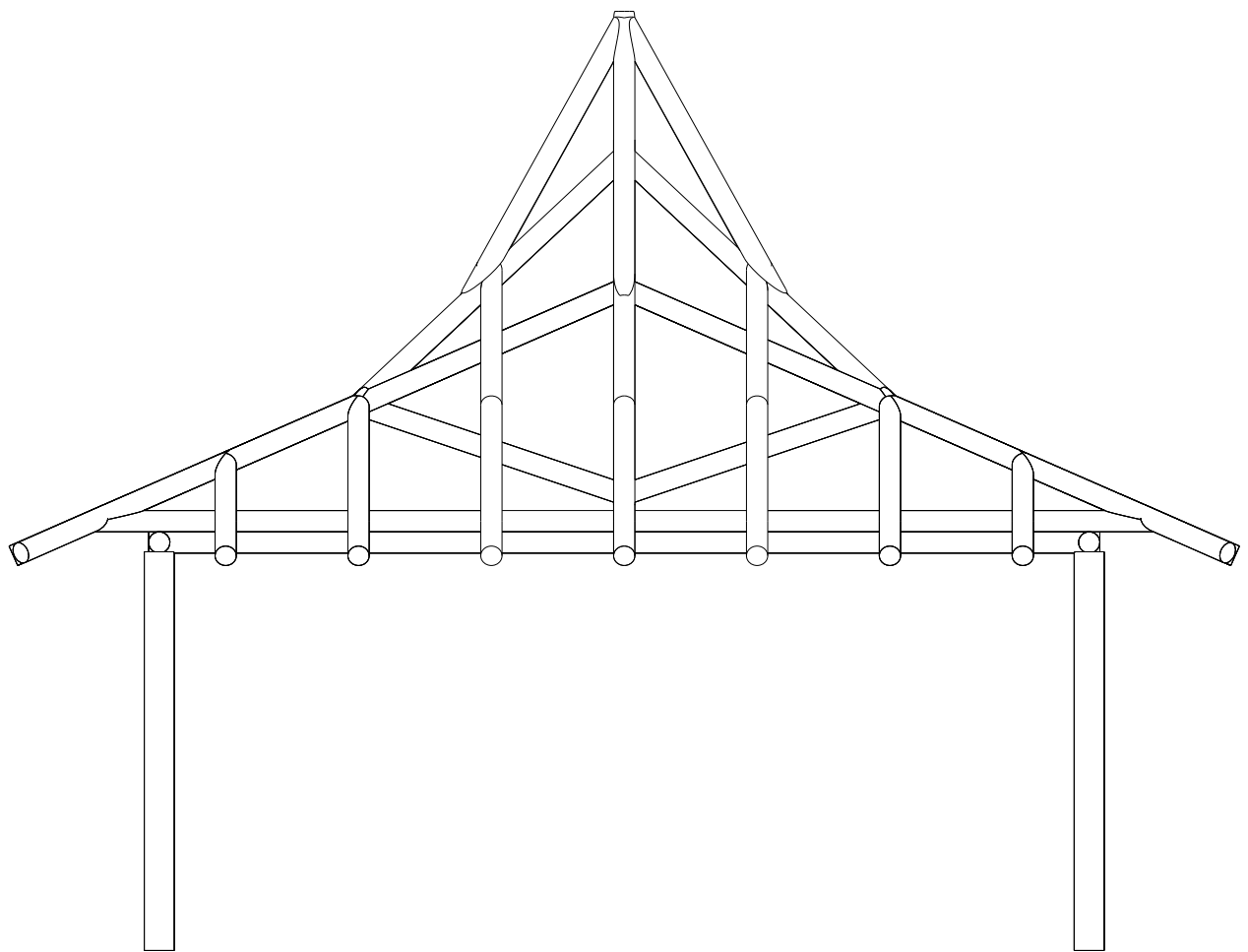

FIG 4.4



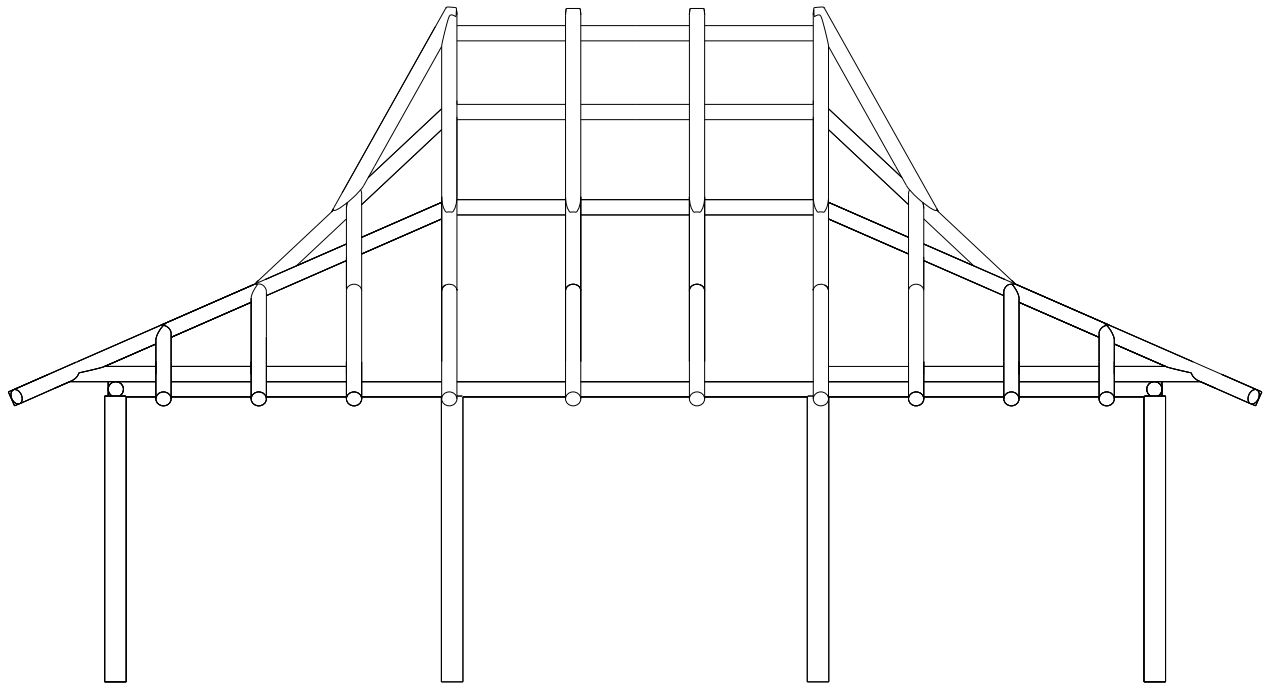

FIG 4.5

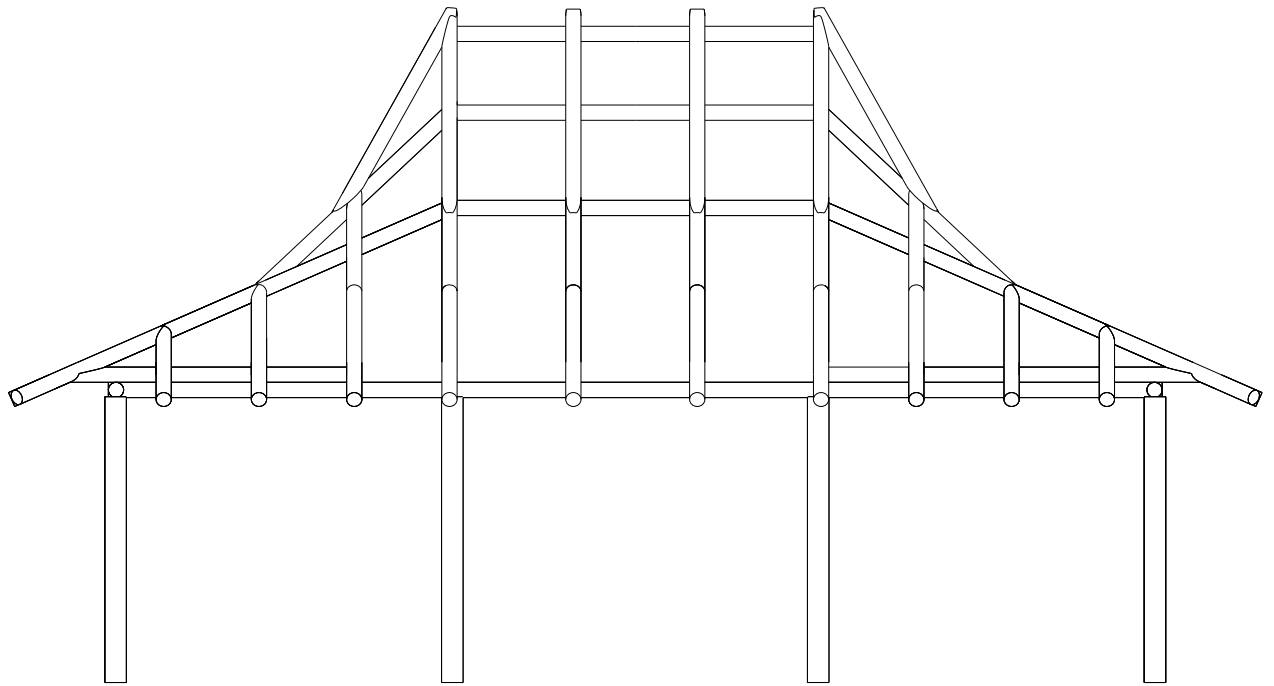

FIG 4.6

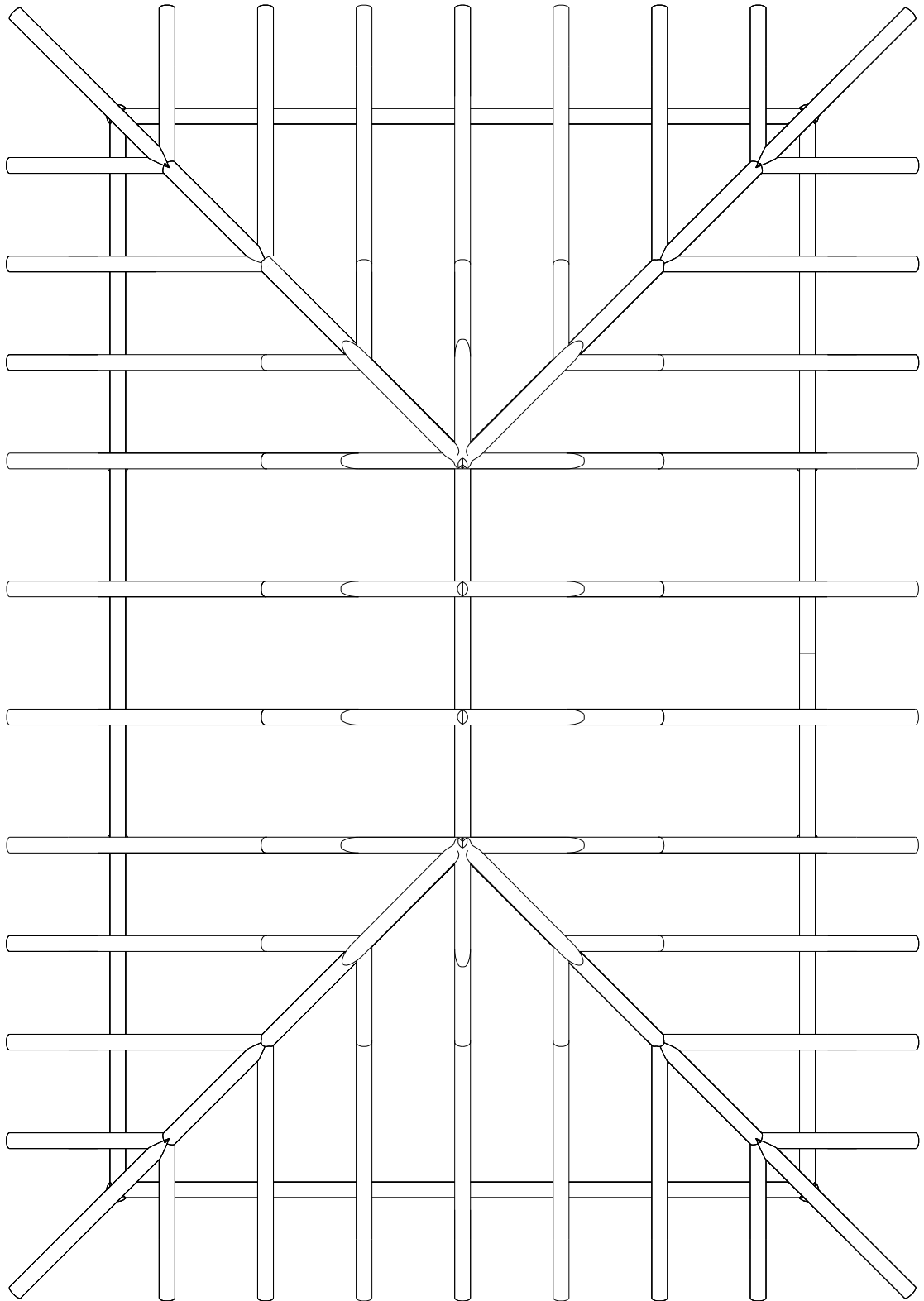

FIG 4.7

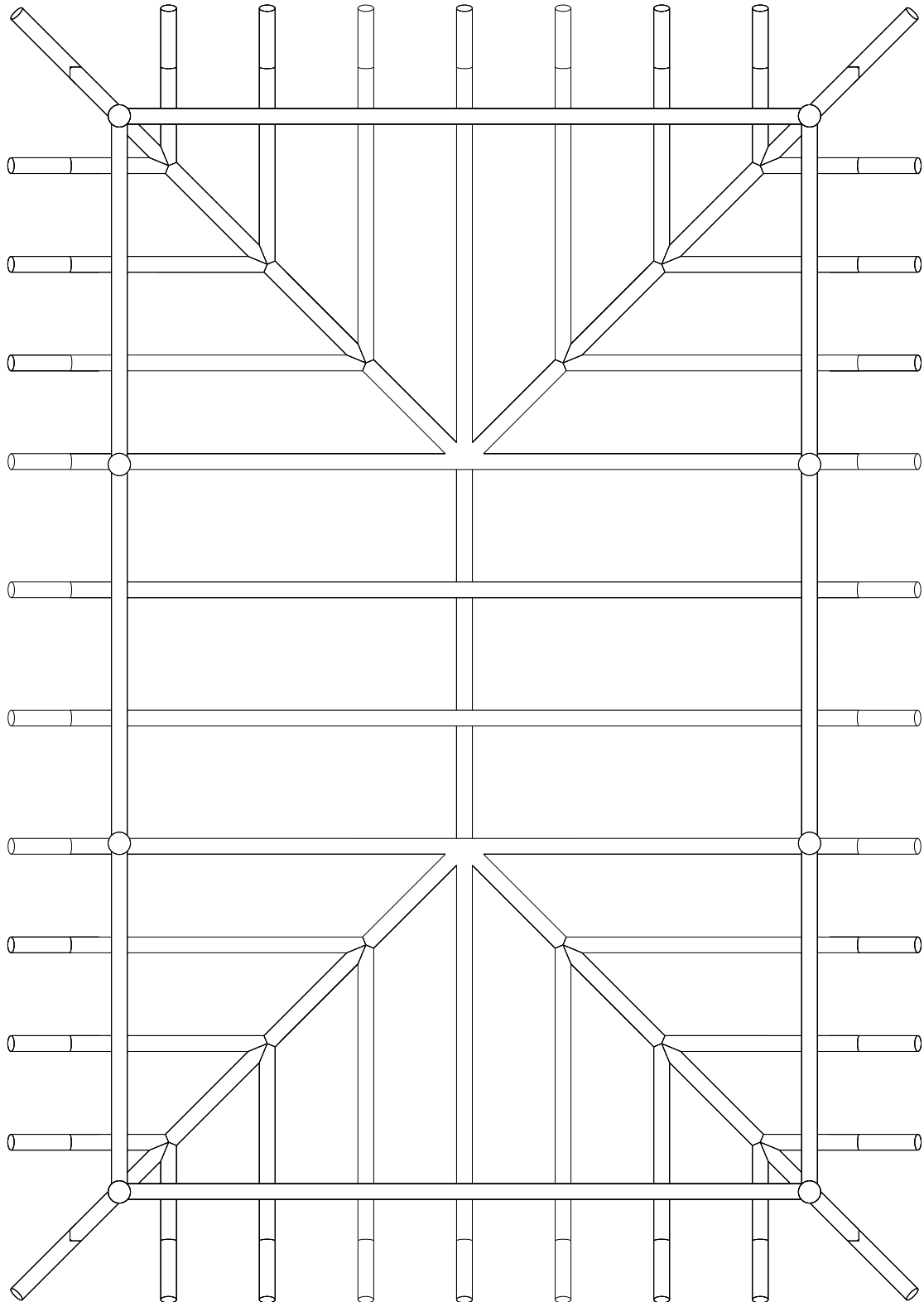

FIG 4.8